

FOR MODELS: SCRASB151916

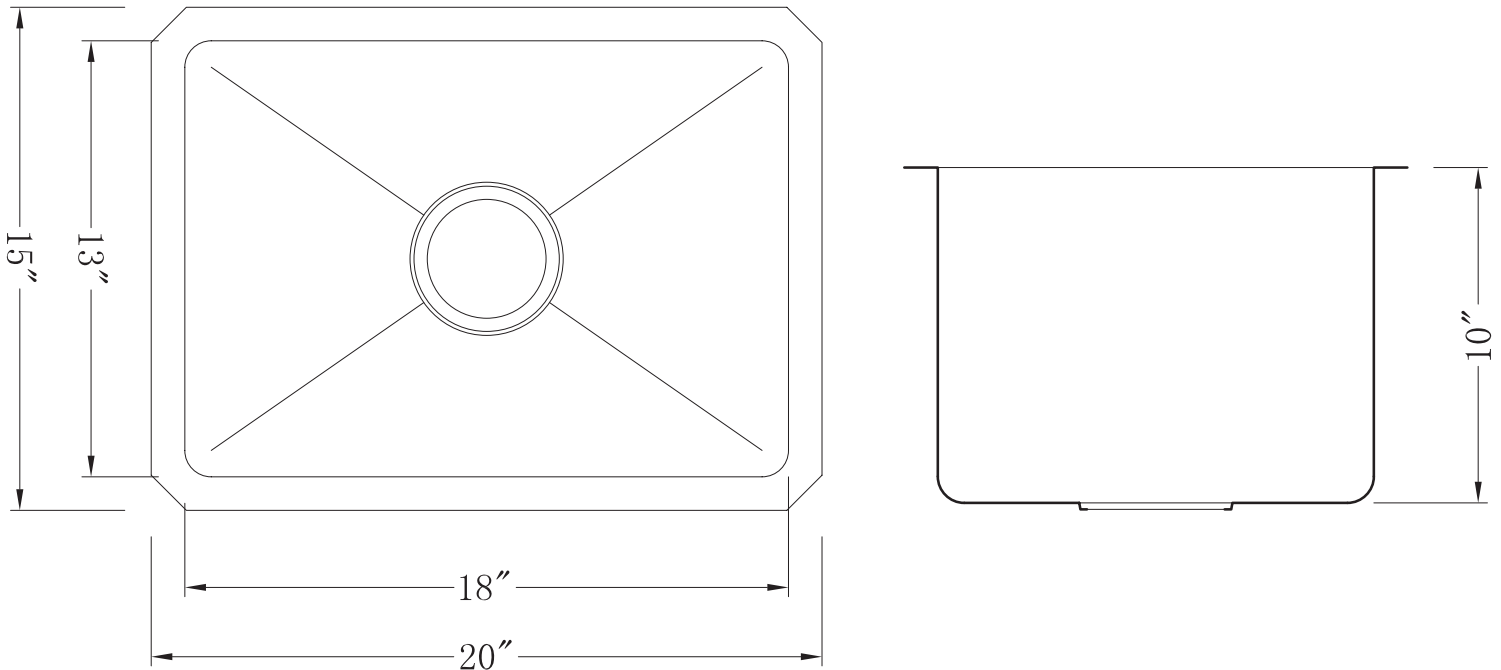

Before You Start

- Schön recommends that all undermount sinks be installed by an experienced, professional installer.
- **IMPORTANT:** The enclosed cutout template will create a countertop opening with a minimal (1/8" or less) reveal. It is recommended that you discuss this with your installer and agree that this finished appearance is the desired effect. Schön is not responsible for improper sink or countertop installations.
- **IMPORTANT:** The cabinet must be installed, secured, plumb, and level. Failure of this step can lead to product damage.
- Schön undermount sinks should only be fastened to a solid surface countertop (i.e. granite, Corian® or Silestone®).
- Schön is not responsible for sink or countertop if damaged during installation. Be sure to inspect the sink for damage prior to beginning installation.
- Metal edges may be sharp – use caution when handling.
- Follow all local plumbing and building codes.

Recommended Tools & Materials (Not Included)

- | | |
|--|--|
| <input type="checkbox"/> Tape Measure | <input type="checkbox"/> Shims or Cabinet Fillers |
| <input type="checkbox"/> Safety Glasses | <input type="checkbox"/> Denatured Alcohol |
| <input type="checkbox"/> Painter's Tape | <input type="checkbox"/> Clamps |
| <input type="checkbox"/> Level | <input type="checkbox"/> Construction Adhesive |
| <input type="checkbox"/> Framing Square | <input type="checkbox"/> Silicone Sealant |
| <input type="checkbox"/> Pencil (not permanent marker) | <input type="checkbox"/> Screws (recommended by countertop manufacturer) |

1: PREP COUNTERTOP

OUTLINE FOR UNDERMOUNT SINK CUTOUT

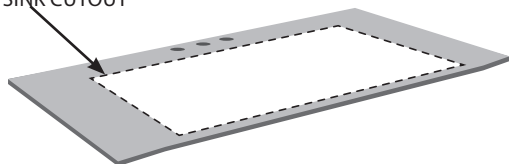

MOUNTING BRACKET

FASTENER

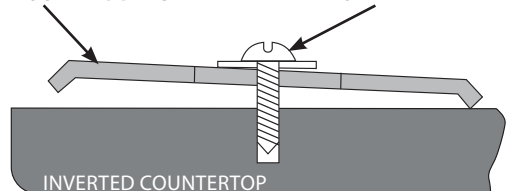

INVERTED COUNTERTOP

1. Position the template (provided with your sink) front to rear so the sink will not interfere with the cabinet; secure with tape.
 2. Trace the template and remove. Dry fit the sink to verify the measurements.
 4. Following the countertop manufacturer's instructions, carefully cut the countertop on the inside of the traced line.
 5. Locate and drill the mounting holes, following the countertop manufacturer's instructions. Holes should allow even spacing of mounting brackets around the sink.
 6. With the countertop inverted (upside down), fasten the mounting brackets to the countertop loosely.
- ▲ **IMPORTANT:** The cabinet must be installed, secured, plumb, and level BEFORE installing the sink.
- ▲ **IMPORTANT:** Schön undermount sinks should only be fastened to a solid surface countertop (i.e. granite, Corian® or Silestone®).

2: INSTALL COUNTERTOP

APPLY SILICONE SEALANT AFTER CLEANING THE SINK EDGE AND COUNTERTOP

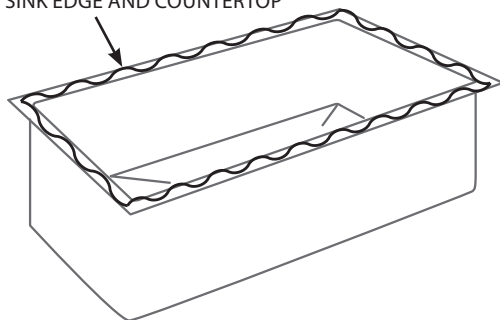

VERIFY SINK IS CENTERED WITHIN THE COUNTERTOP OPENING BEFORE TIGHTENING FASTENERS.

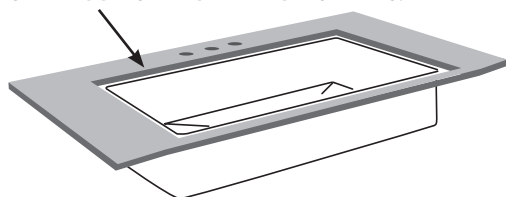

1. Clean the bottom of the countertop and the top flange (or lip) of the sink with denatured alcohol.
 2. Apply a narrow bead of silicone adhesive sealant evenly all around the top of the sink flanges.
 3. Position and align the sink over the countertop opening. Press silicone onto countertop.
 4. Tighten fasteners until mounting brackets are snug against sink. Check alignment of sink to the countertop opening.
 5. Tighten down fasteners evenly. Be careful not to over-tighten.
 6. Immediately remove excess sealant.
- ▲ **IMPORTANT:** The enclosed cutout template will create a countertop opening with a minimal (1/8" or less) reveal. It is recommended that you discuss this with your installer and agree that this finished appearance is the desired effect. Schön is not responsible for improper sink or countertop installations.
- ▲ **IMPORTANT:** Schön is not responsible for sink or countertop if damaged during installation. Be sure to inspect the sink for damage prior to beginning installation.

3: FINAL STEPS

1. Following all local plumbing and building codes, install the faucet according to the manufacturer's instructions.
 2. Connect the drain and piping.
 3. Run water into the sink and check all connections for leaks.
- ▲ **IMPORTANT:** For additional information or warranty issues visit www.schonsimplymodern.com or contact Schön directly at:
 Schön Warranty Dept, World Imports Decorative Plumbing
 3074 Chastain Meadows Parkway
 Marietta, GA 30066
 (800) 880-8164